

INSTALLATION DETAILS IN FIRE CONTAINER

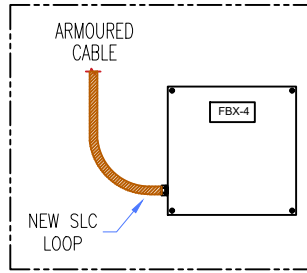

DETALLE "A"

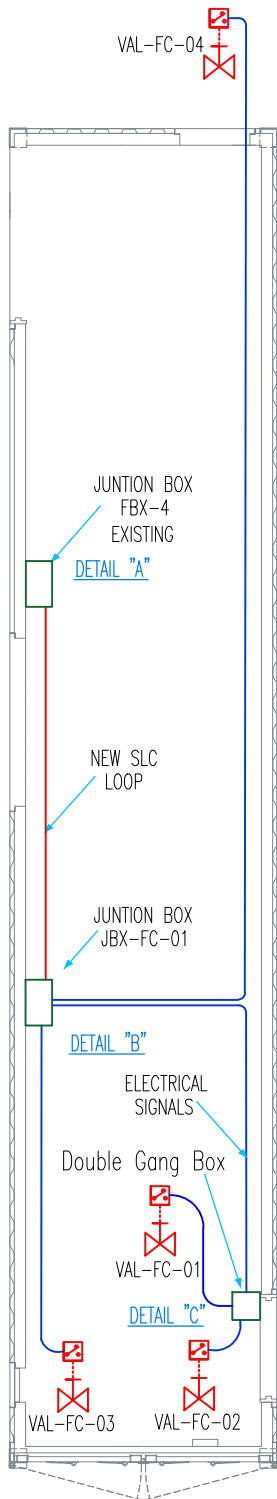
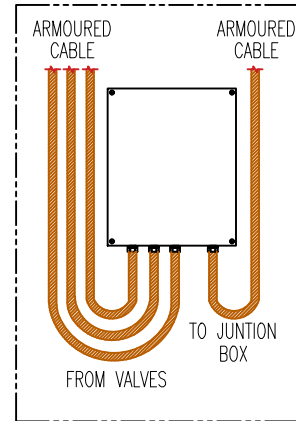

DETALLE "B"

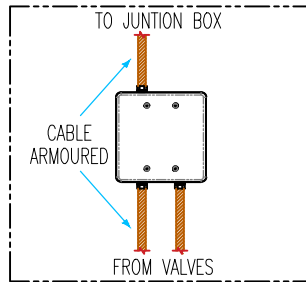

DETALLE "C"

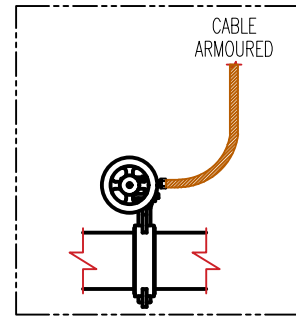

VALVE DETAIL

LEYEND	
TYPE	DESCRIPTION
— (Blue line)	ELECTRICAL SIGNAL OF THE VALVE
— (Red line)	NEW SLC LOOP

THIS DOCUMENT IS THE INTELLECTUAL PROPERTY OF FIRENO S.A.S AND ZIJIN - ROSEBEL GOLD MINES

REV.	DESCRIPTION	DATE
B	FOR APPROVAL	
A	INTERNAL REVIEW	08-24
REVISIONS		

fireno
ENERGIA PER IL TERRITORIO
QUALITÀ PER IL CLIENTE

PROJECT: ZIJIN - ROSEBEL GOLD MINES ENGINEERING SERVICES FOR INTEGRATION OF BUTTERFLY VALVES AT SARAMACCA PLANT					
TITLE: INSTALLATION DETAILS IN PLAN VIEW IN FIRE CONTAINER					
DRAWING: F.R.C.	REVIEWED: J.P.	FORMAT: A4	DRAWING NUMBER: FRN-ZIJIN-BV-DWG-01		
DESIGNED: F.D.L.	APPROVED: J.M.	DATE: 08-24	SHEET: 1 of 3	SCALE: S/E	REVISION: A

INSTALLATION DETAILS IN COMPLEX BUILDING

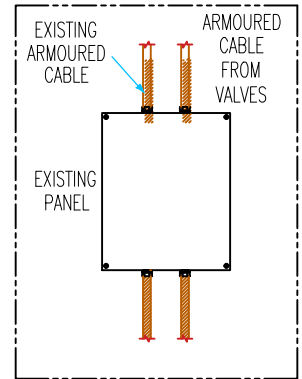

DETAILLE "A"

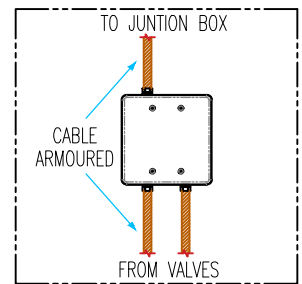

DETAILLE "B"

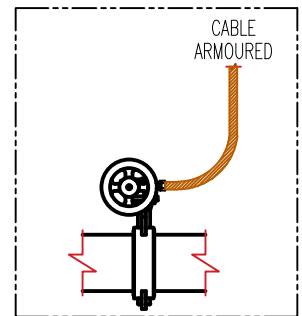

VALVE DETAIL

LEYEND	
TYPE	DESCRIPTION
— (Blue line)	ELECTRICAL SIGNAL OF THE VALVE
— (Red line)	NEW SLC LOOP

THIS DOCUMENT IS THE INTELLECTUAL PROPERTY OF FIRENO S.A.S AND ZIJIN – ROSEBEL GOLD MINES

		PROJECT: ZIJIN – ROSEBEL GOLD MINES ENGINEERING SERVICES FOR INTEGRATION OF BUTTERFLY VALVES AT SARAMACCA PLANT							
		TITLE: INSTALLATION DETAILS IN PLAN VIEW IN COMPLEX BUILDING							
REV.	DESCRIPTION	DATE		DRAWING: F.R.C.	REVIEWED: J.P.	FORMAT: A4	DRAWING NUMBER: FRN-ZIJIN-BV-DWG-02		
REVISIONS				DESIGNED: F.D.L.	APPROVED: J.M.	DATE: 08-24	SHEET: 2 of 3	SCALE: S/E	REVISION: A

INSTALLATION DETAILS IN TRUCK SHOP

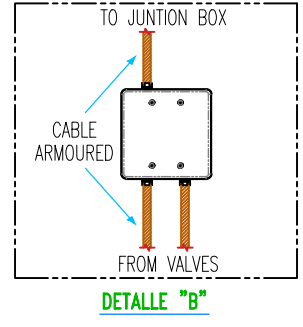
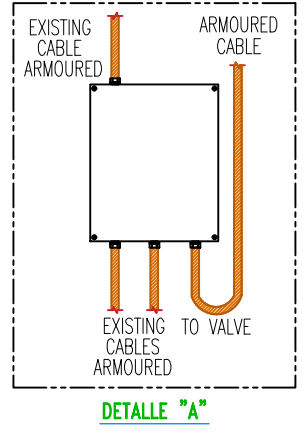
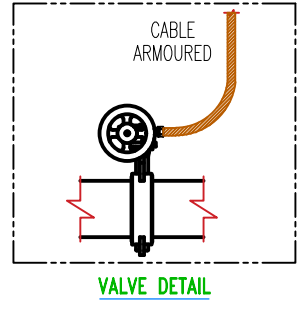
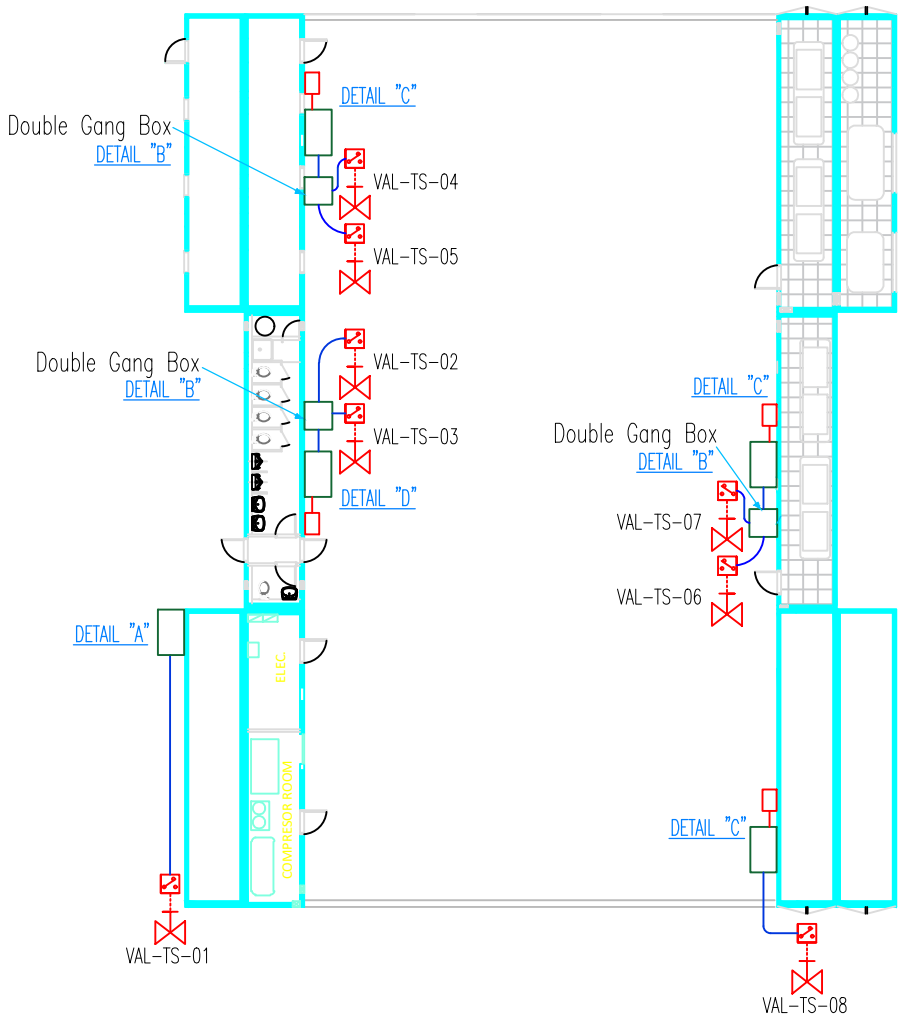

LEND	
TYPE	DESCRIPTION
— (blue line)	ELECTRICAL SIGNAL OF THE VALVE
— (red line)	NEW SLC LOOP

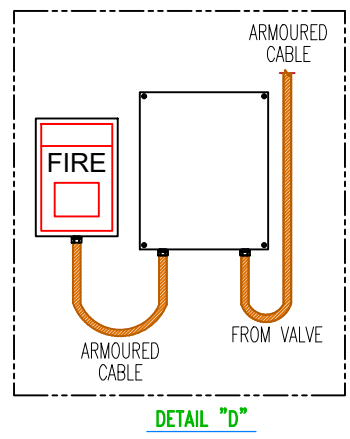
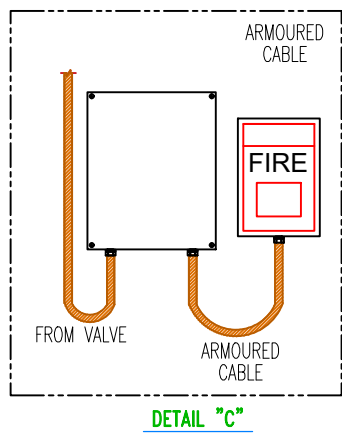

REV.	DESCRIPTION	DATE
B	FOR APPROVAL	
A	INTERNAL REVIEW	08-24
REVISIONS		

PROJECT: ZIJIN – ROSEBEL GOLD MINES
ENGINEERING SERVICES FOR INTEGRATION
OF BUTTERFLY VALVES AT SARAMACCA PLANT

TITLE: INSTALLATION DETAILS IN PLAN VIEW
IN TRUCK SHOP

DRAWING: F.R.C.	REVIEWED: J.P.	FORMAT: A4	DRAWING NUMBER: FRN-ZIJIN-BV-DWG-01
DESIGNED: F.D.L.	APPROVED: J.M.	DATE: 08-24	SHEET: 3 of 3
		SCALE: S/E	REVISION: A

THIS DOCUMENT IS THE INTELLECTUAL PROPERTY OF FIRENO S.A.S AND ZIJIN – ROSEBEL GOLD MINES